



EXAMINATIONS COUNCIL OF ZAMBIA

GRADE SEVEN COMPOSITE EXAMINATION – 2016

Special Paper 2

SUBJECT 7/1

60 MINUTES

TD/SP2/G7/2016

- 1 Read these instructions carefully.
- 2 **DO NOT** turn this page before you are told. Your teacher will tell you when to turn this page to begin writing the questions.
- 3 There are **50** questions in this **Special Paper Two** paper. You will be given **exactly 60 minutes** to do the questions.
- 4 For each question, four answers are given, but only one of the four is right. Work out which is the **best** answer. Then, on your **Answer Sheet**, mark the box completely by shading the answer space of the letter of your choice. If you had chosen answer D for a question, you would show it like this:-

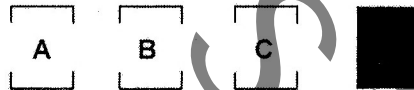

- 5 You must **SHADE** your answer spaces **completely** and **darkly** using an HB pencil. If you have to change your answer, you must rub out the shading **very neatly** before shading the new one. **Use a clean rubber.**
- 6 When you have finished one page, go straight on without waiting to be told. If you have time left at the end of the question paper, use it to check your work carefully.
- 7 Look at your **Answer Sheet**. On the top left hand side are boxes which should have, Examination Year, your School Number and Examination Number. It should also say **Subject 7 Paper 1**.
- 8 Look at your **Answer Sheet** again. At the bottom left hand side, it should have your Surname, Forename, Subject – Special Paper Two, Name of Primary School and your Secondary School of choice.
- 9 **Put up your hand now if:**
 - You have any question.
 - You have the wrong answer sheet.

You will not be able to ask questions once the examination has begun.

**DO NOT TURN THIS PAGE UNTIL YOU ARE TOLD.
USE ONLY AN HB PENCIL FOR YOUR ANSWERS.**

1 WHICH ONE COMES NEXT?

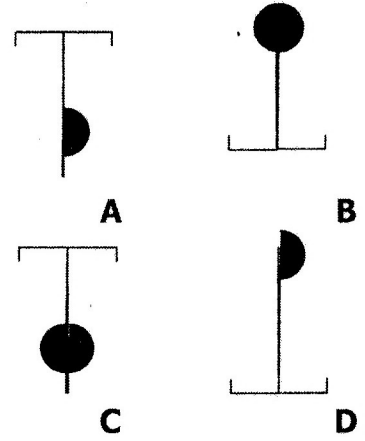
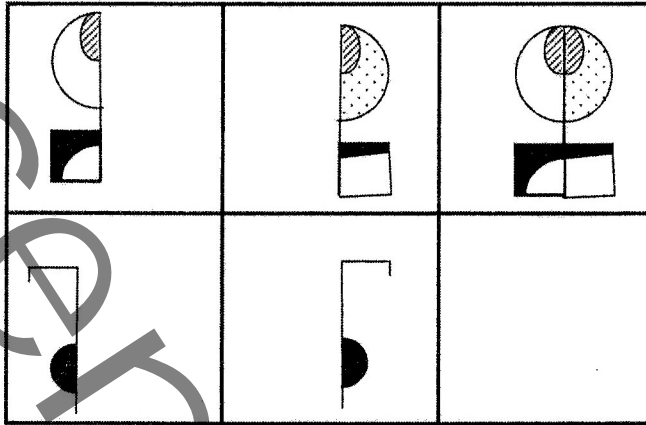

2 WHICH ONE COMES NEXT?

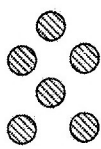
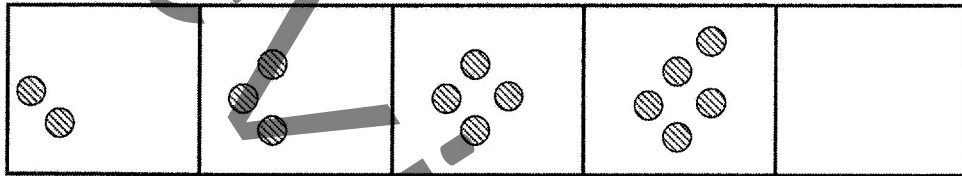

A

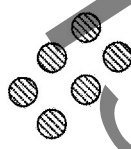

B



C

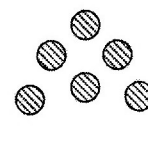

D

3 WHICH ONE COMES NEXT?

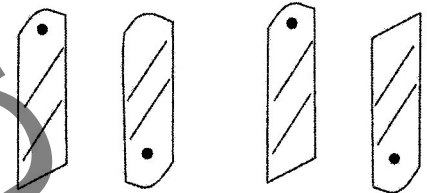
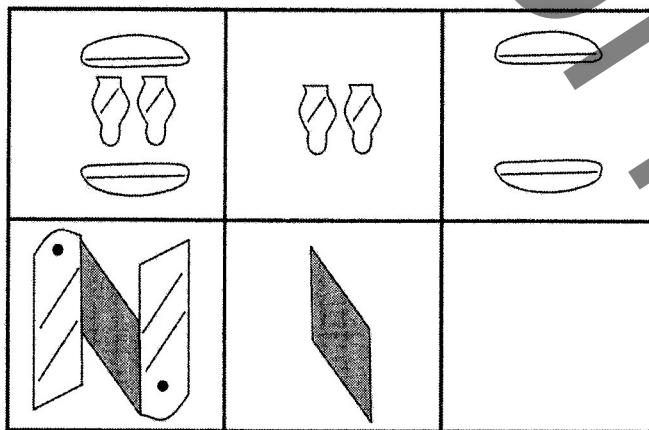

A

B

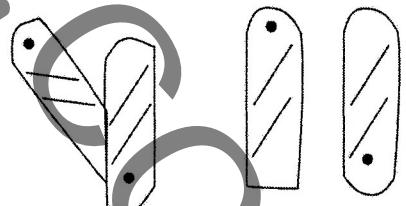

C

D

4 WHICH ONE COMES NEXT?

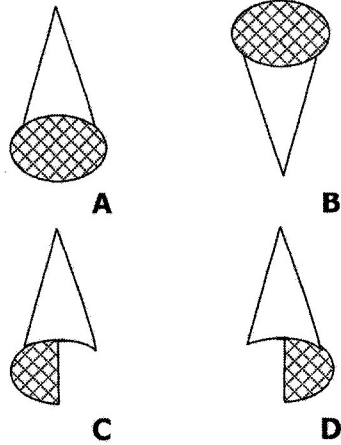
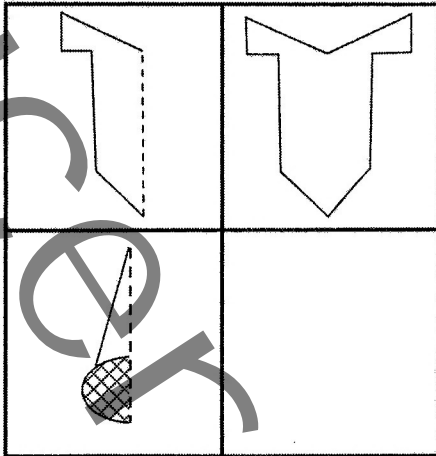

5 WHICH ONE COMES NEXT?

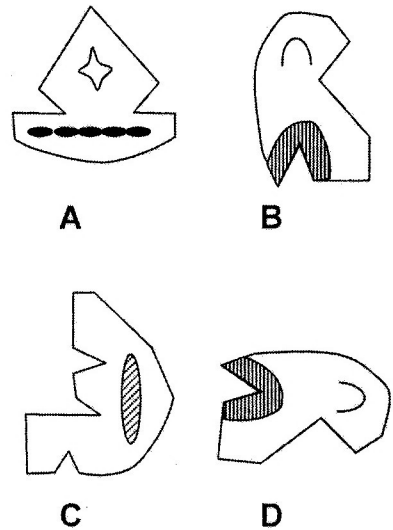
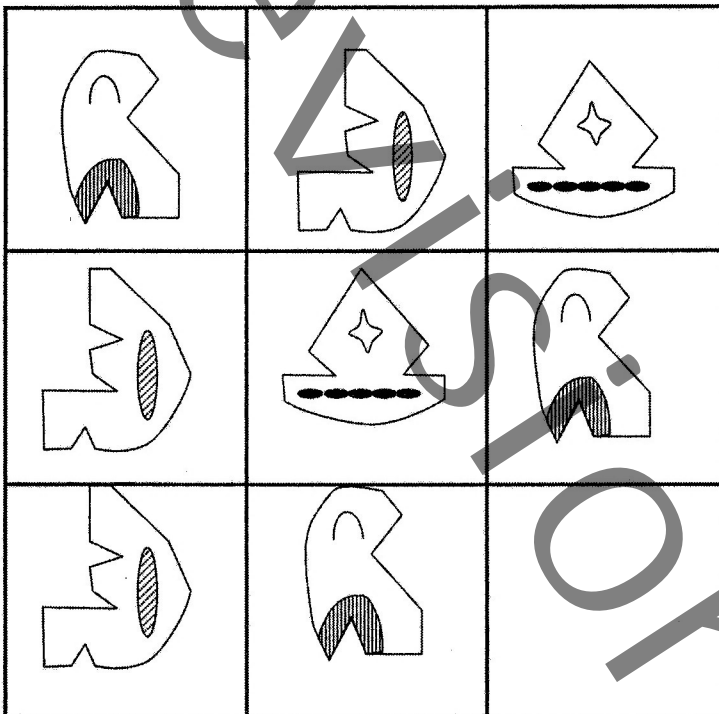

6 WHICH ONE COMES NEXT?

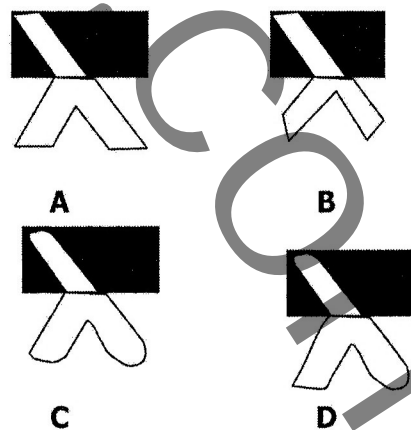
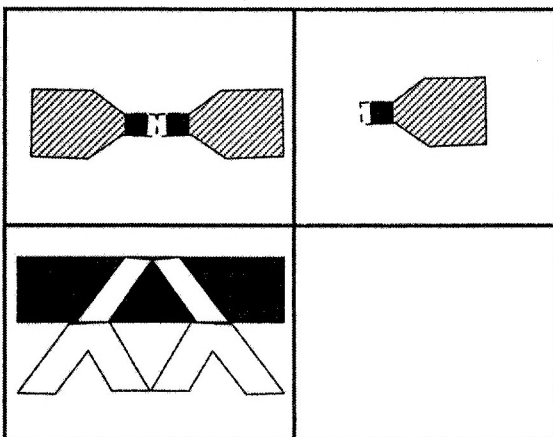

7 WHICH ONE COMES NEXT?

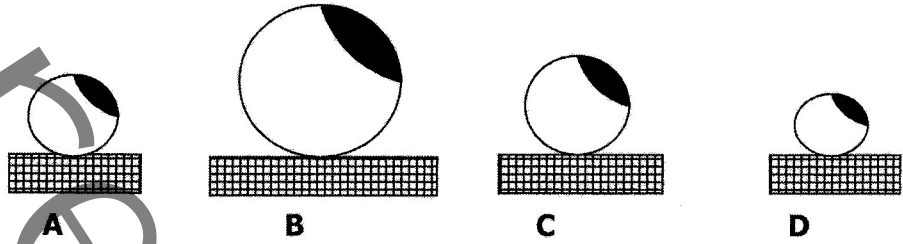
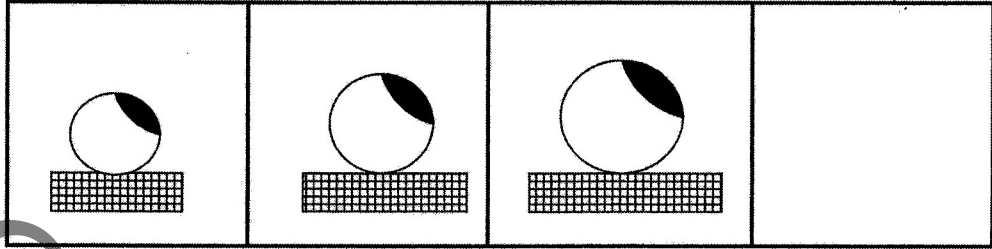

8 WHICH ONE COMES NEXT?

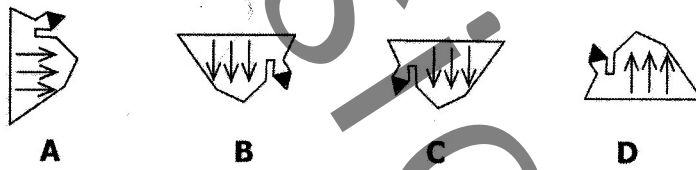
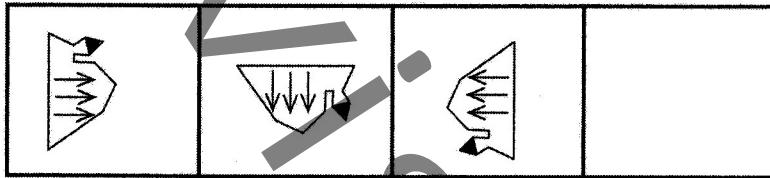

9 WHICH ONE COMES NEXT?

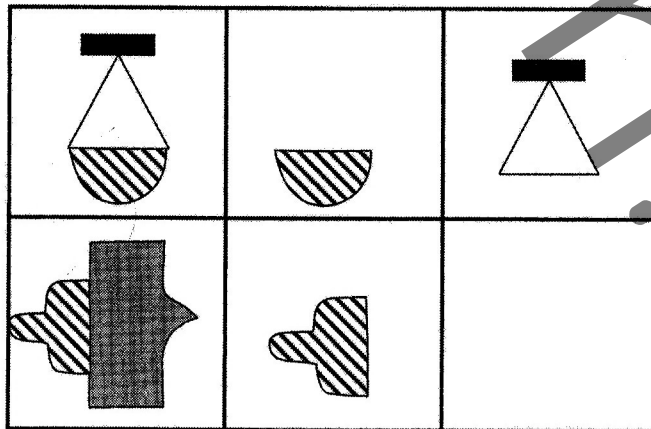

A



B



C

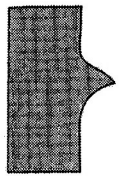

D

10 WHICH ONE IS DIFFERENT?

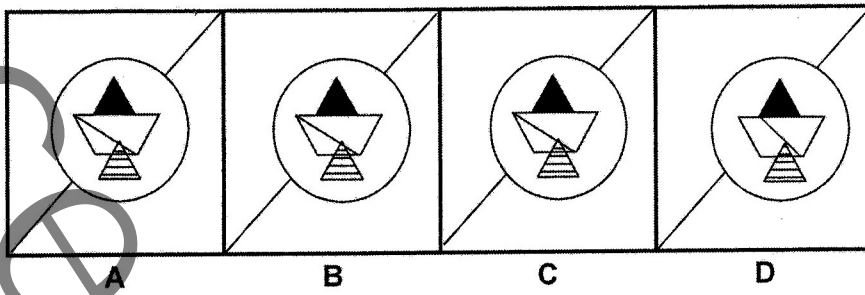

11 WHICH ONE COMES NEXT?

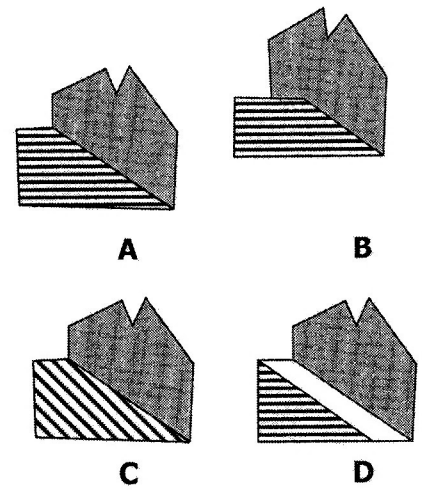
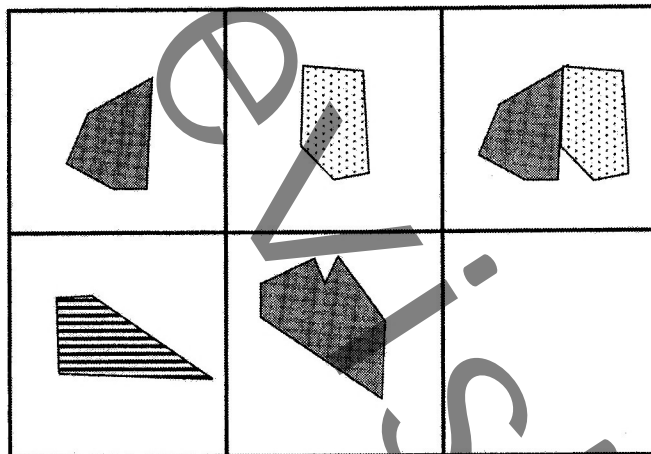

12 WHICH ONE COMES NEXT?

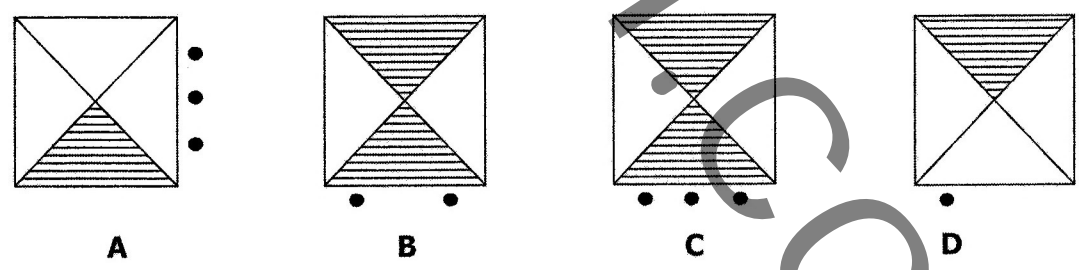
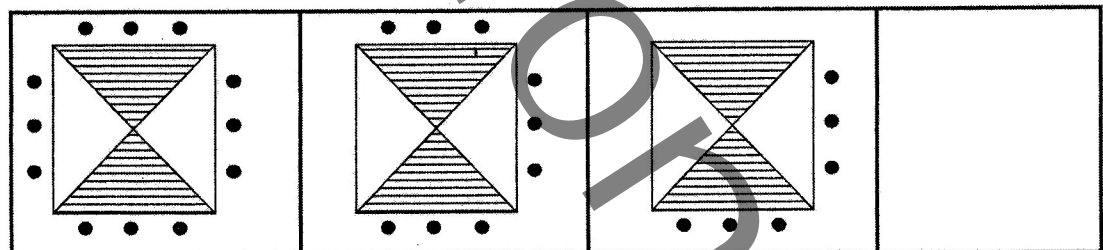

13 WHICH ONE COMES NEXT?

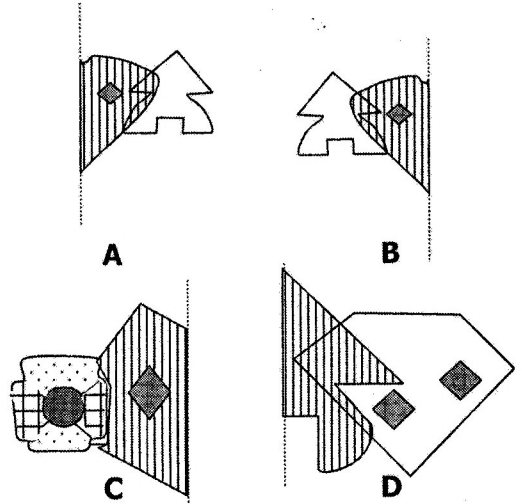
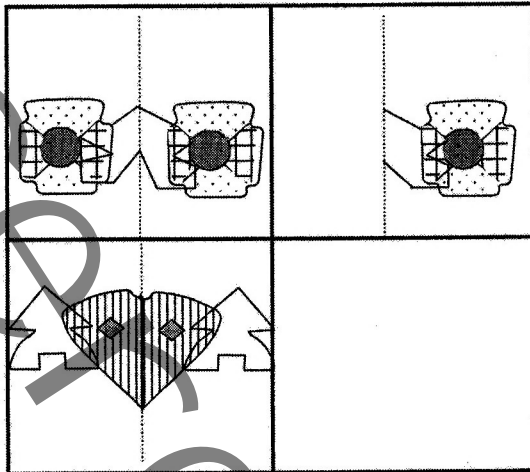

14 WHICH ONE COMES NEXT?

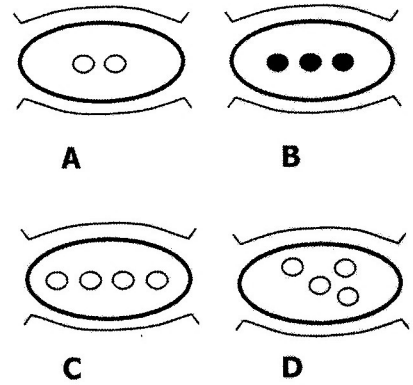
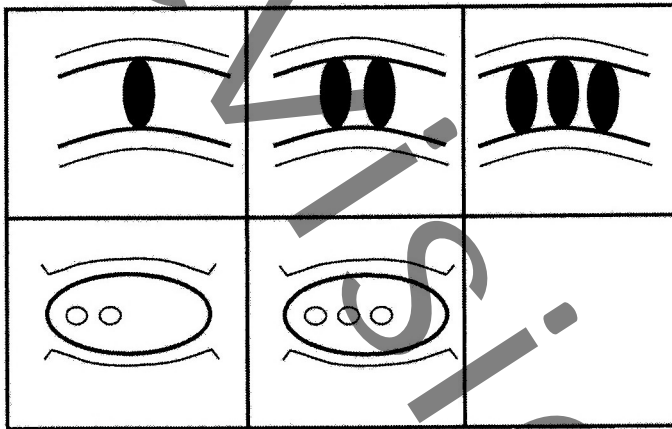

15 WHICH ONE COMES NEXT?

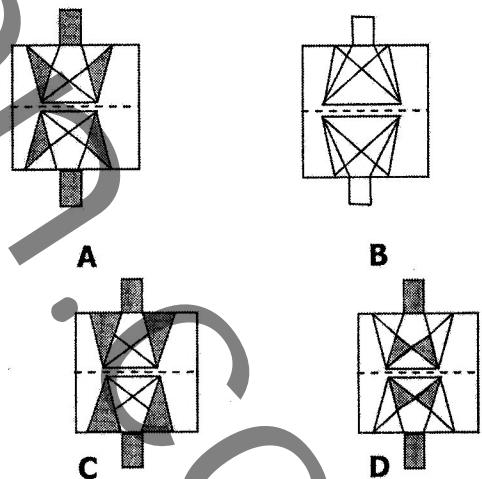
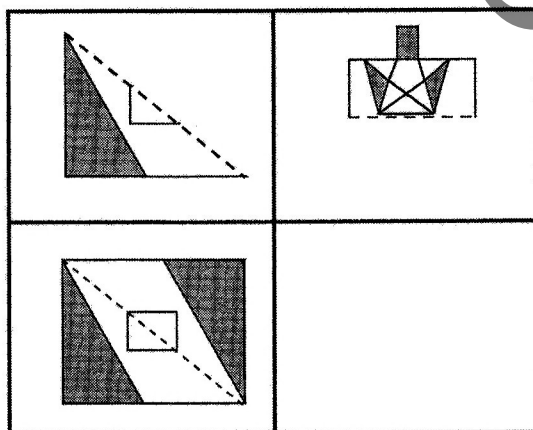

16 WHICH ONE COMES NEXT?

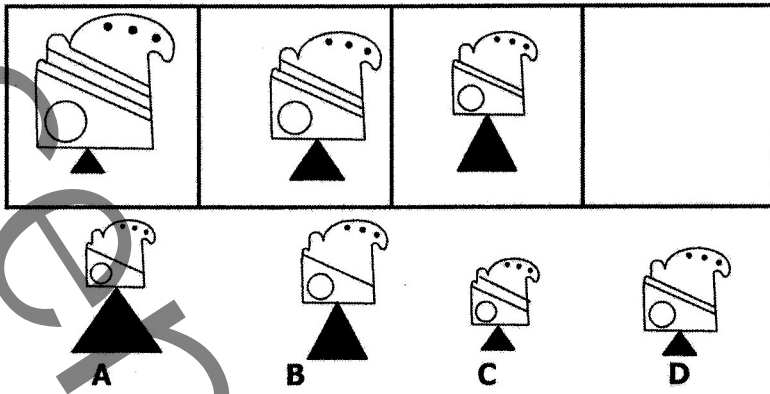

17 WHICH ONE COMES NEXT?

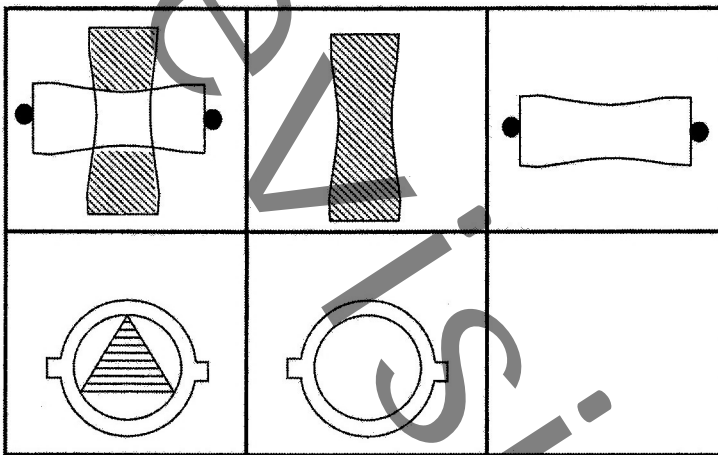

18 WHICH ONE COMES NEXT?

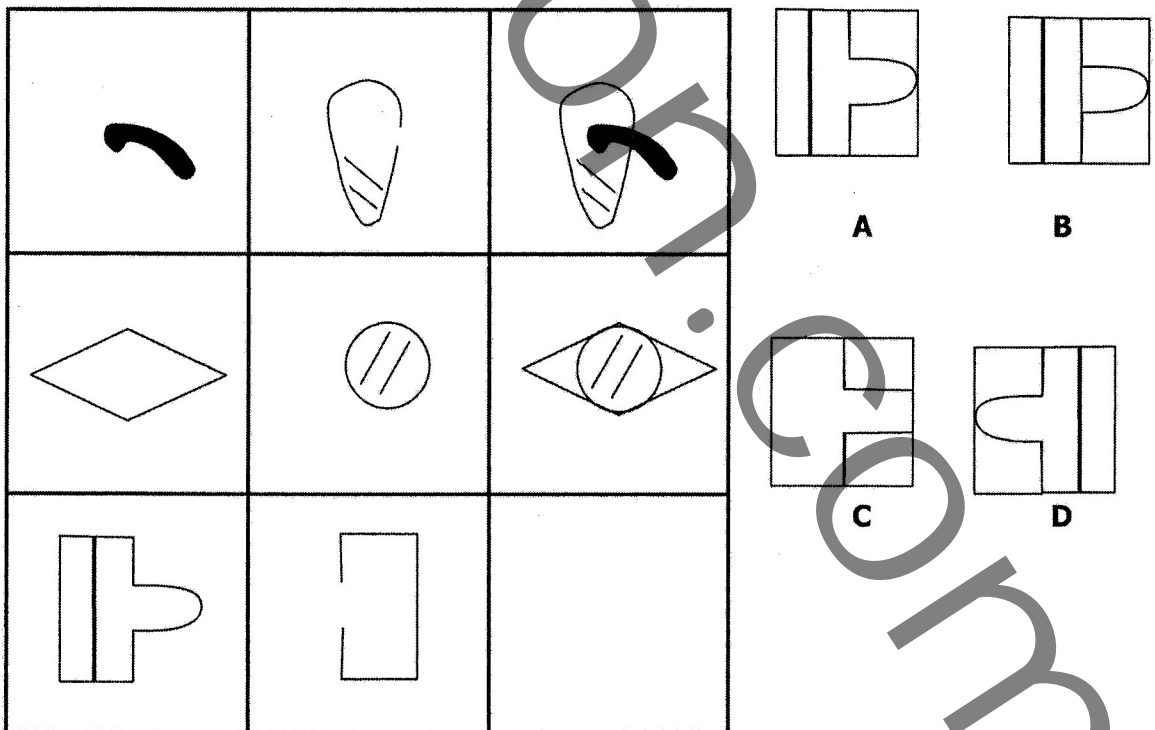

19 WHICH ONE COMES NEXT?

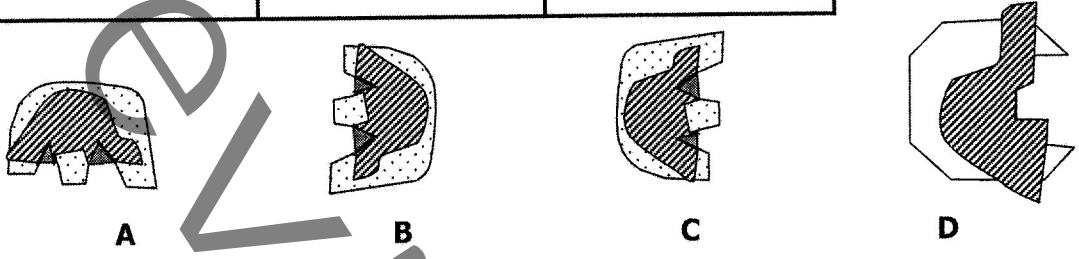
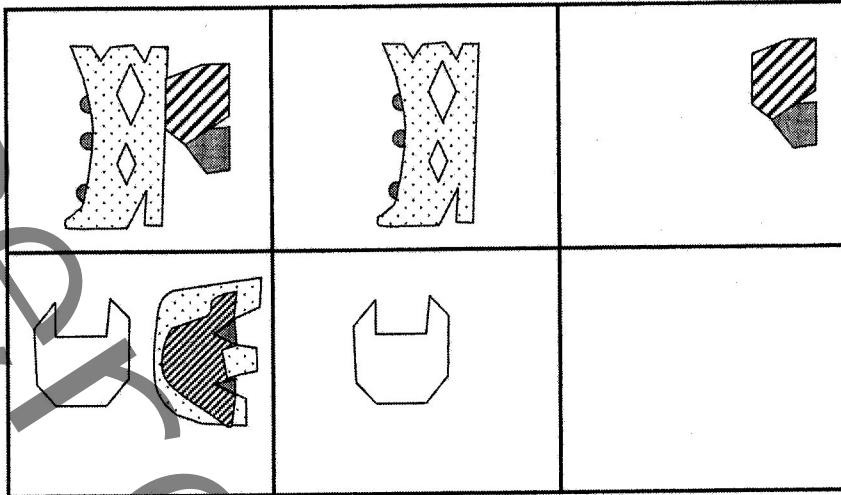

20 WHICH ONE COMES NEXT?

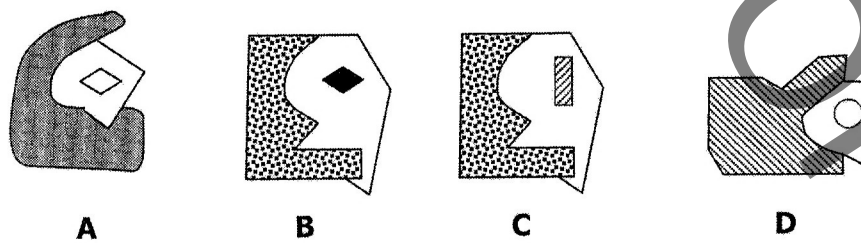
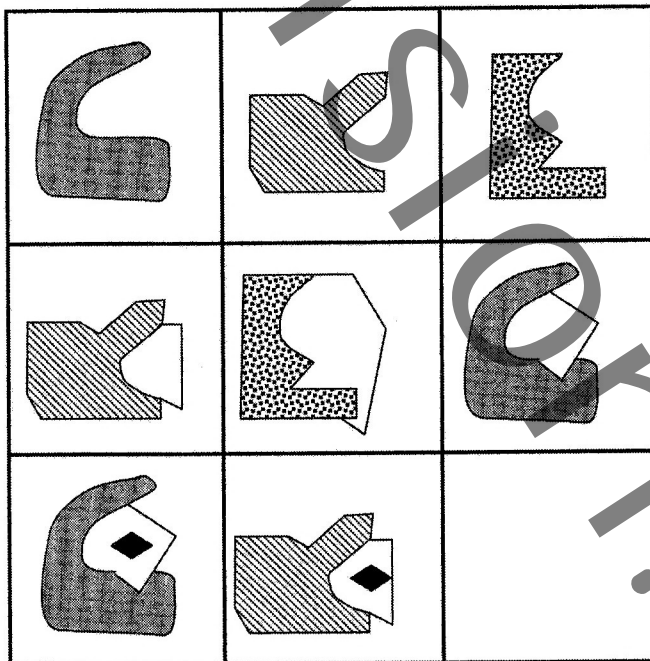

21 WHICH ONE COMES NEXT?

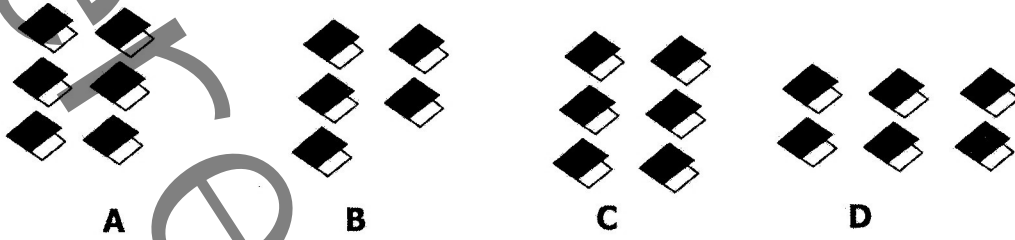
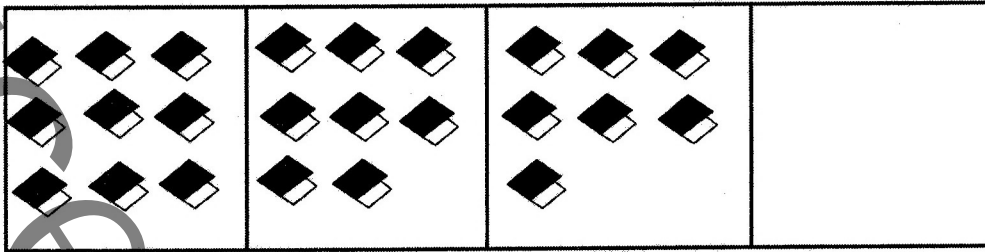

22 WHICH ONE COMES NEXT?

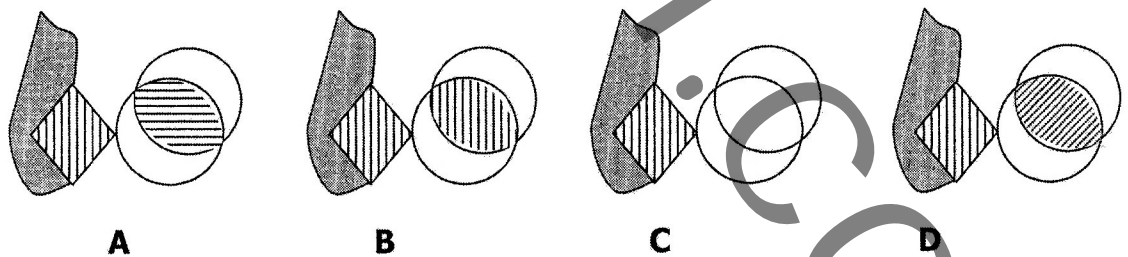
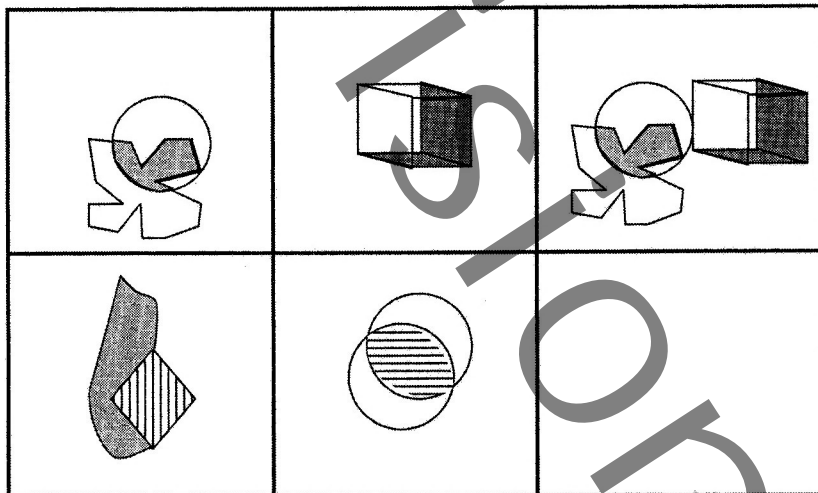

23 WHICH ONE COMES NEXT?

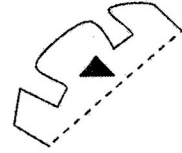
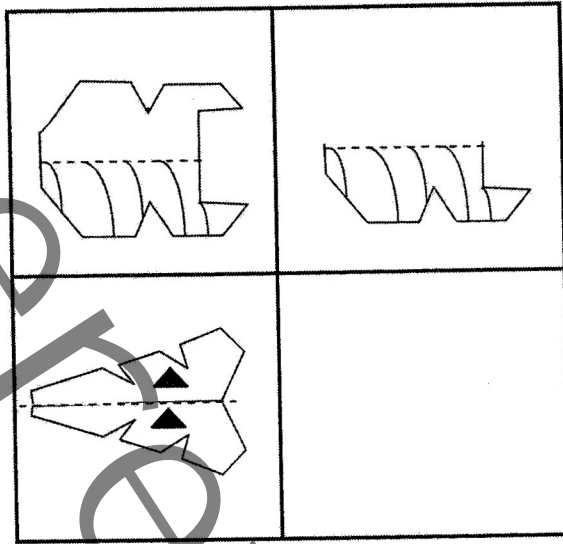

A



B



C

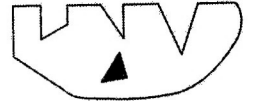

D

24 WHICH ONE COMES NEXT?

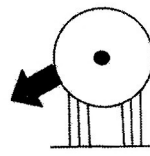
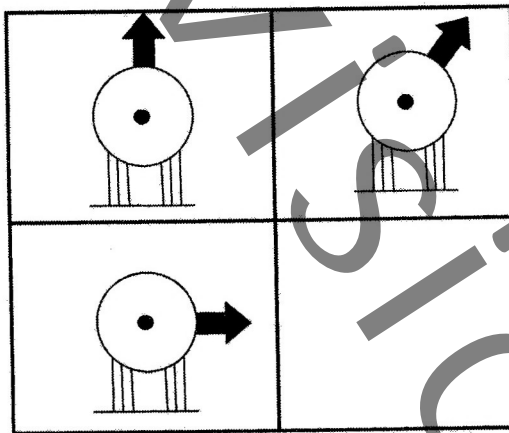

A

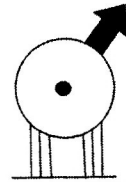

B

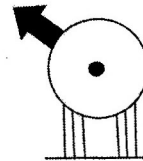

C

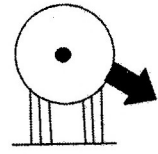

D

25 WHICH ONE COMES NEXT?

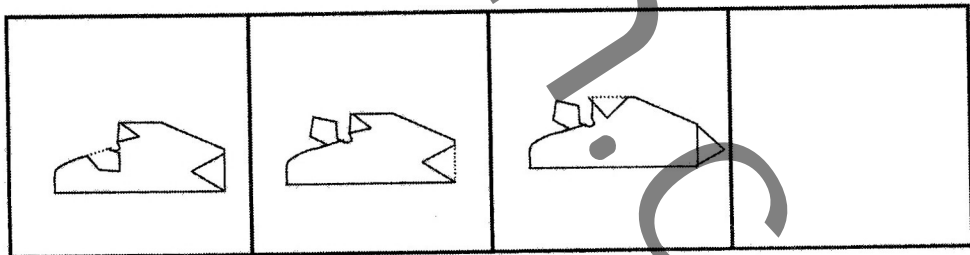

A

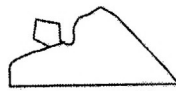

B

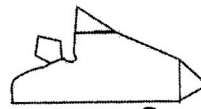

C



D

26 WHICH ONE COMES NEXT?

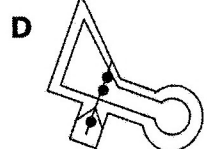
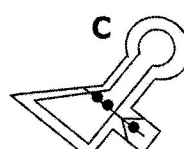
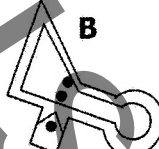
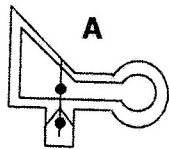
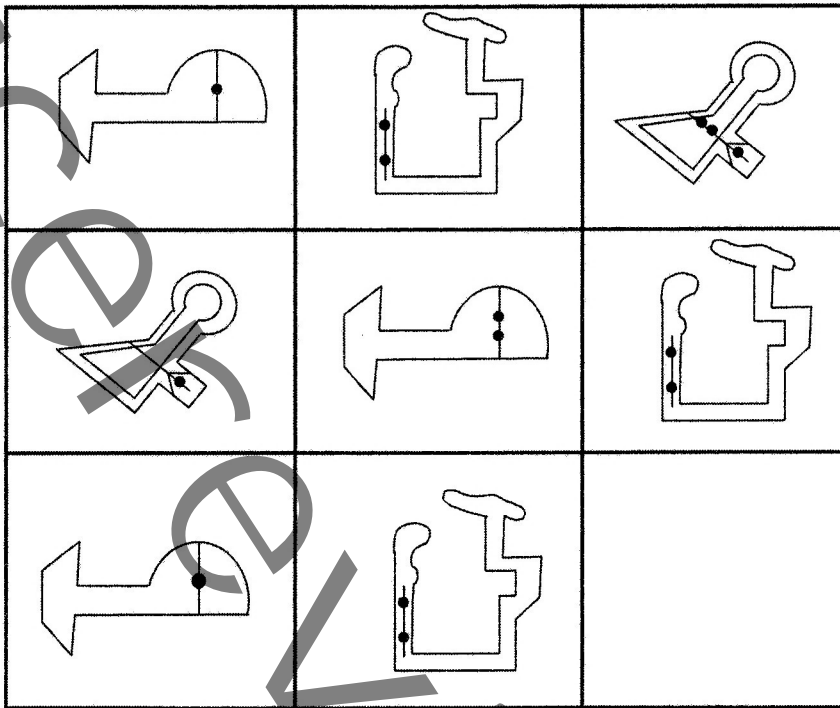

27 WHICH ONE COMES NEXT?

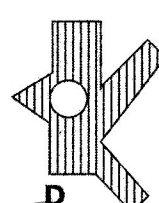
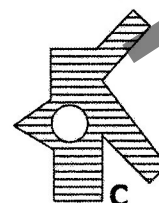
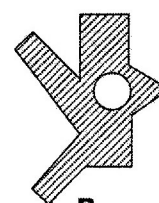
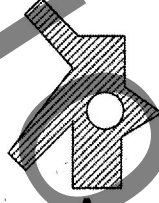
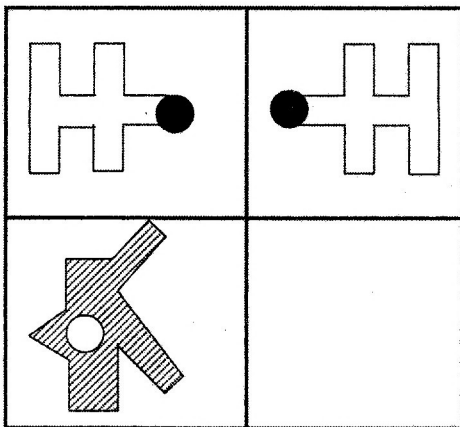

28 WHICH ONE IS DIFFERENT?

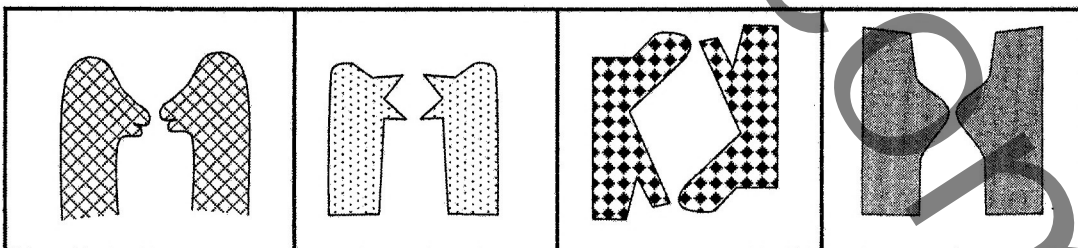

A

B

C

D

29 WHICH ONE COMES NEXT?

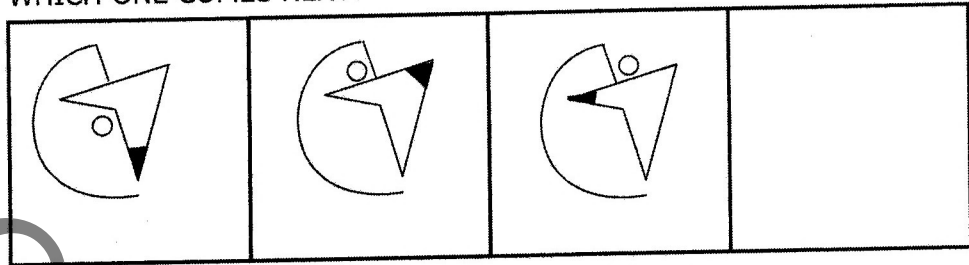

A

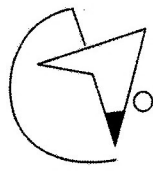

B

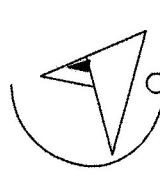

C

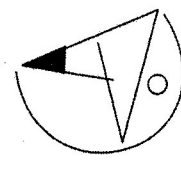

D

30 WHICH ONE COMES NEXT?

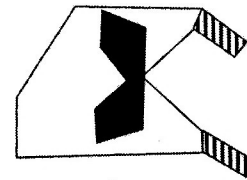
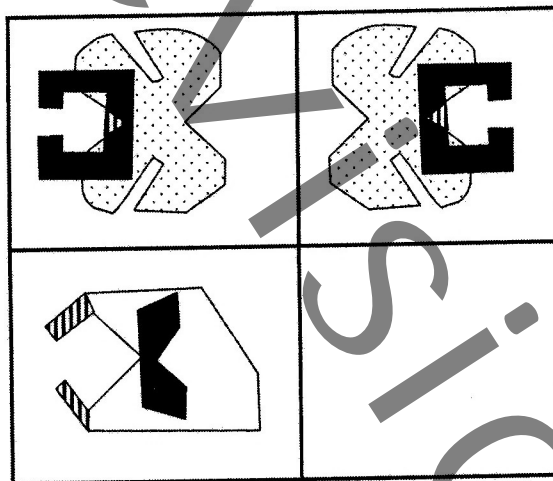

A

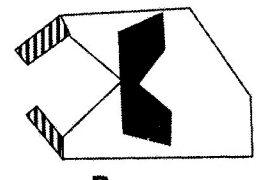

B

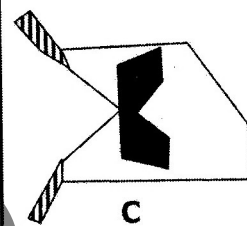

C

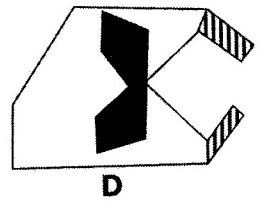

D

31 WHICH ONE IS DIFFERENT?

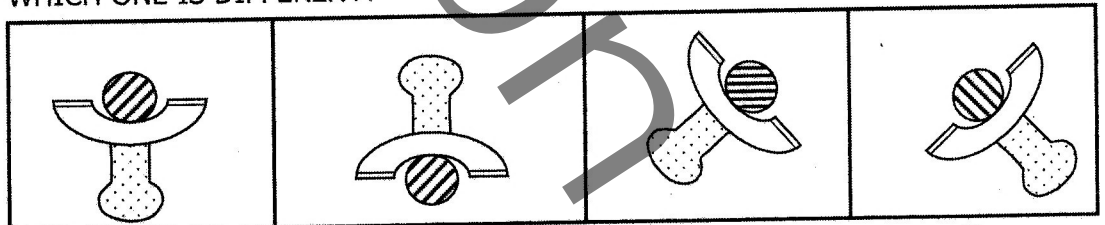

A

B

C

D

32 WHICH ONE IS DIFFERENT?

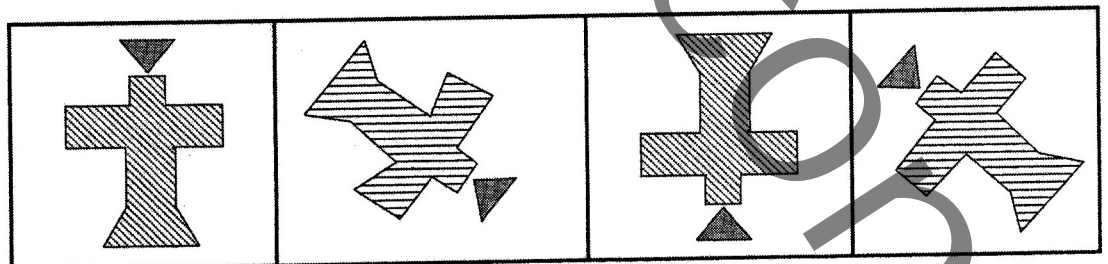

A

B

C

D

33 WHICH ONE COMES NEXT?

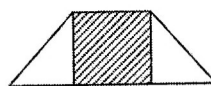
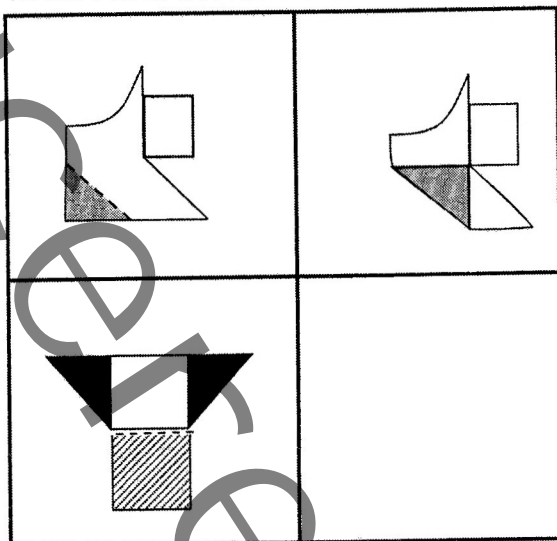

A

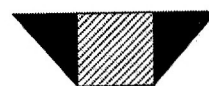

B



C

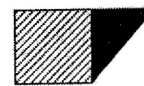

D

34 WHICH ONE COMES NEXT?

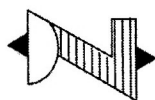
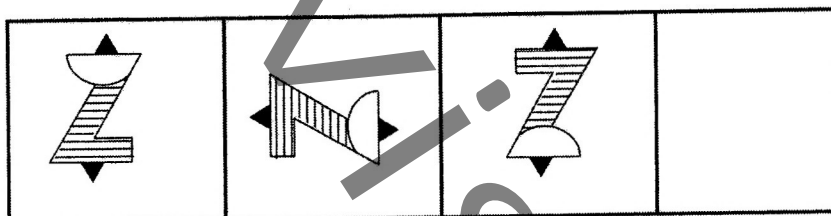

A

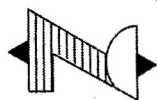

B



C



D

35 WHICH ONE COMES NEXT?

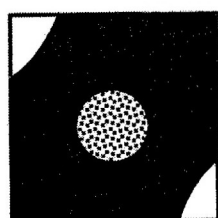
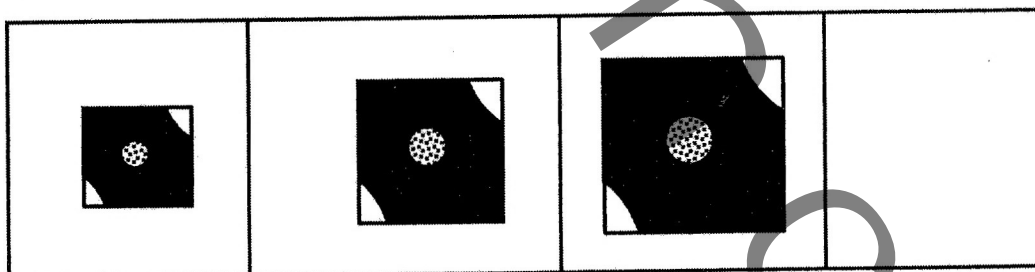

A

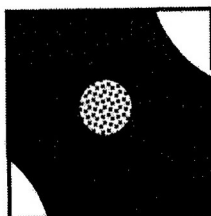

B

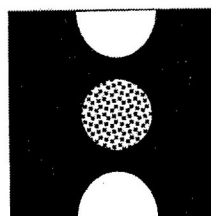

C

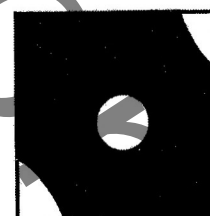

D

36 WHICH ONE COMES NEXT?

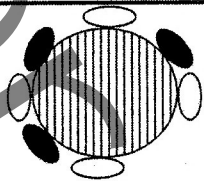
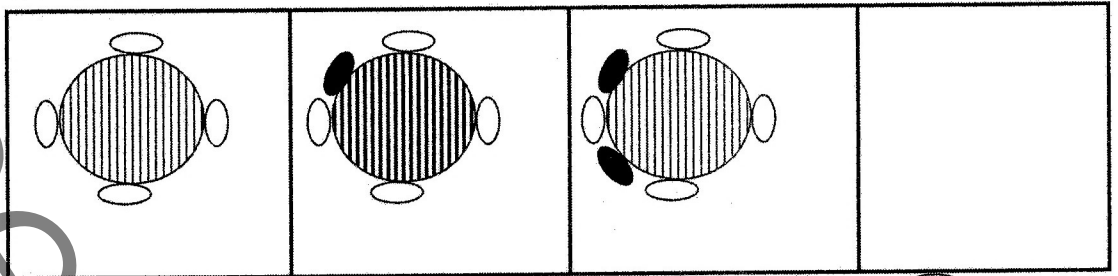

A

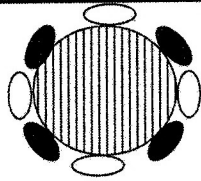

B

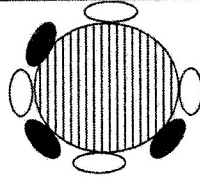

C

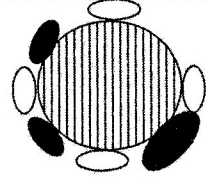

D

37 WHICH ONE COMES NEXT?

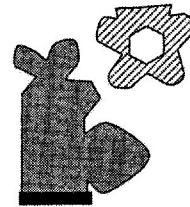
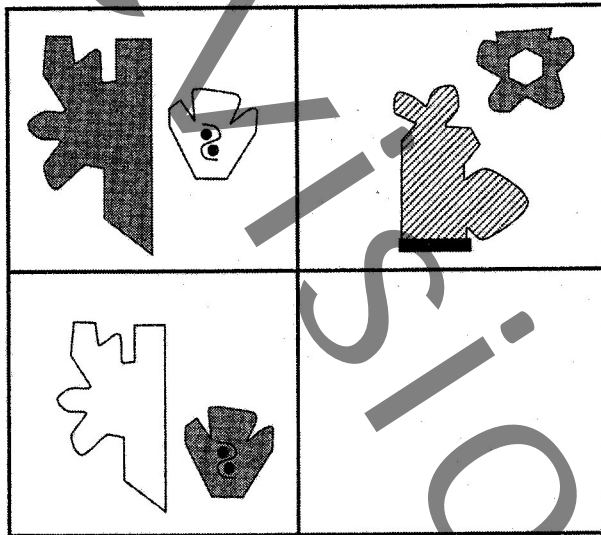

A

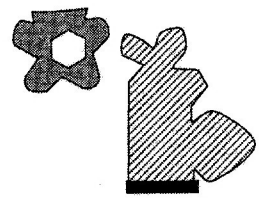

B

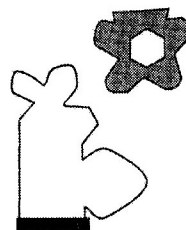

C

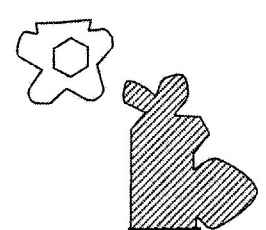

D

38 WHICH ONE COMES NEXT?

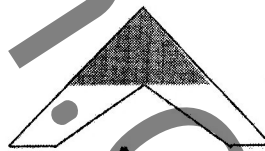
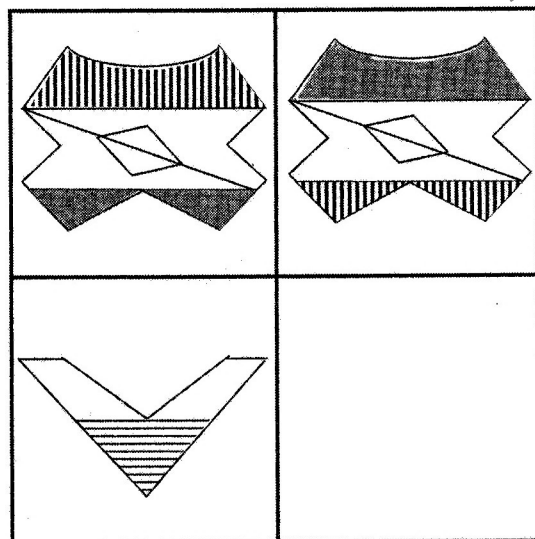

A

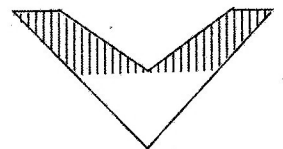

B

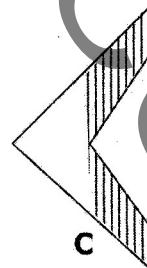

C

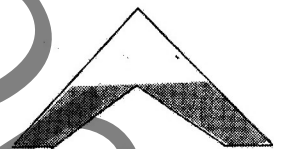

D

39 WHICH ONE IS DIFFERENT?

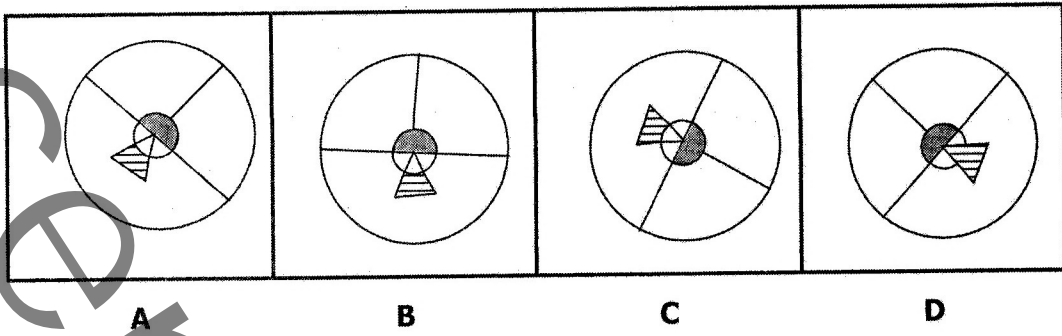

40 WHICH ONE COMES NEXT?

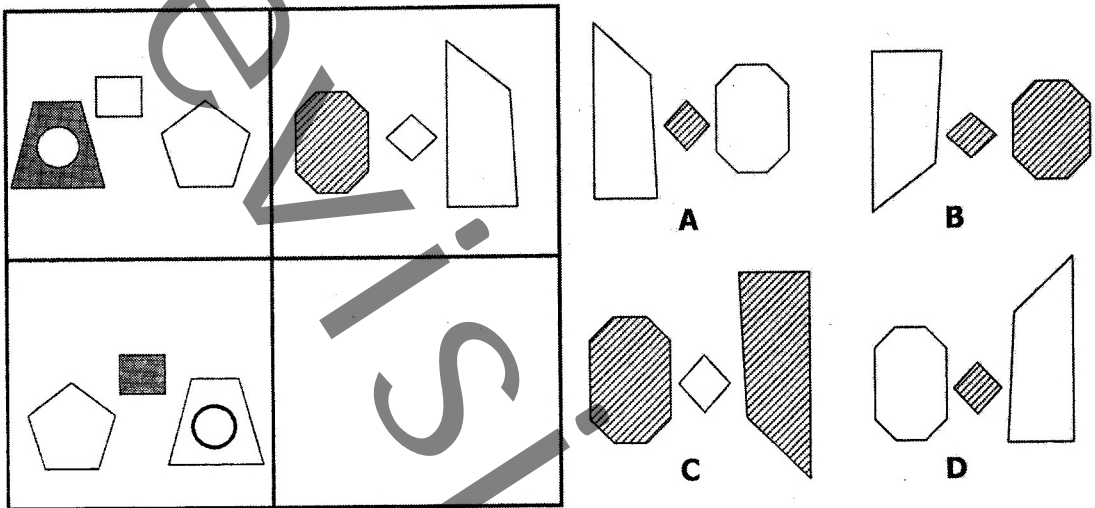

41 WHICH ONE COMES NEXT?

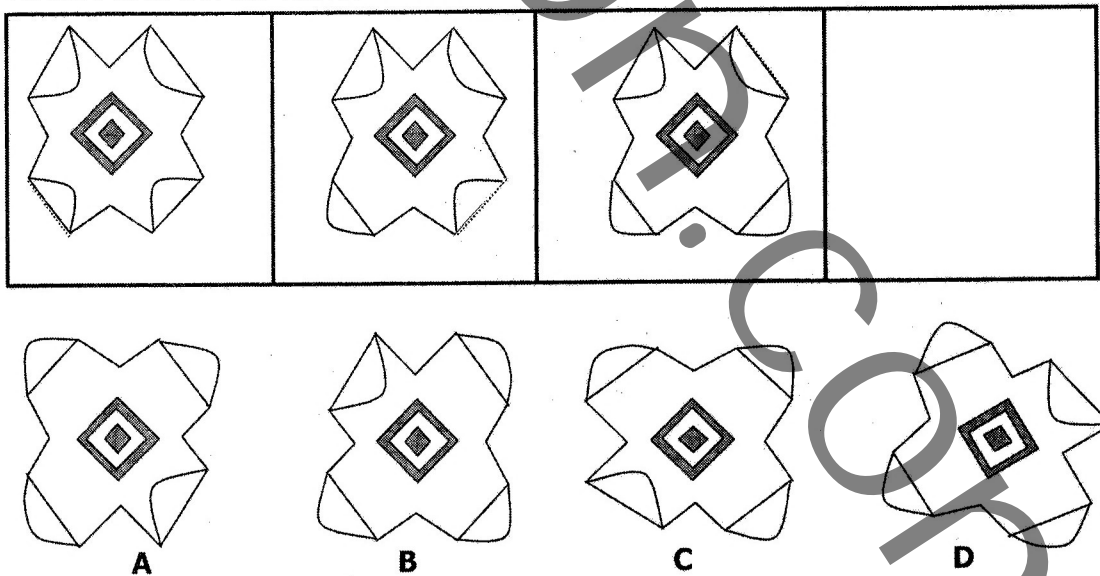

42 WHICH ONE COMES NEXT?

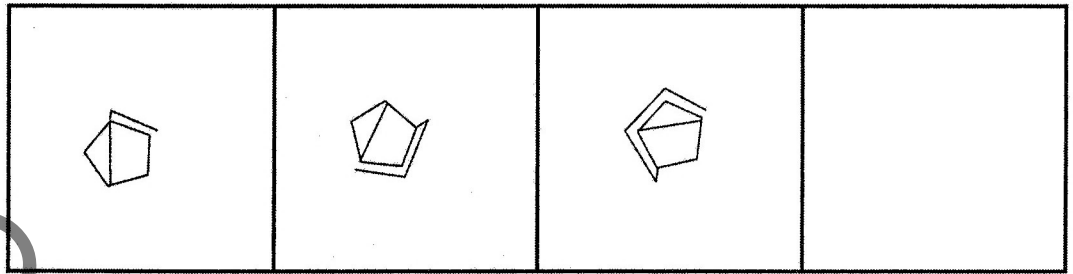

A



B



C



D

43 WHICH ONE COMES NEXT?

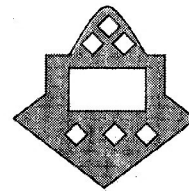
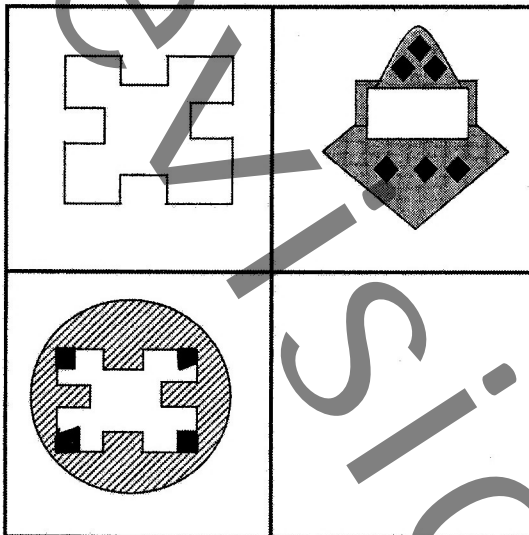

A

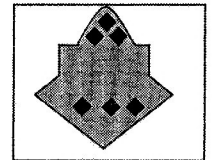

B

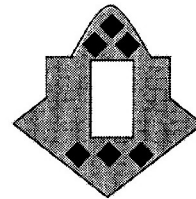

C

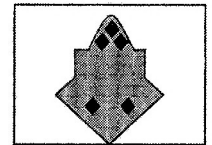

D

44 WHICH ONE COMES NEXT?

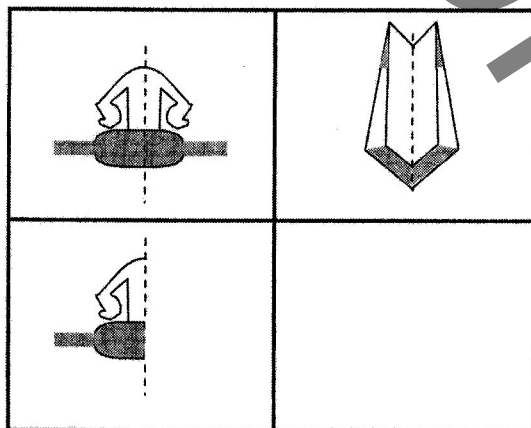

A



B

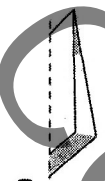

C



D

45 WHICH ONE COMES NEXT?

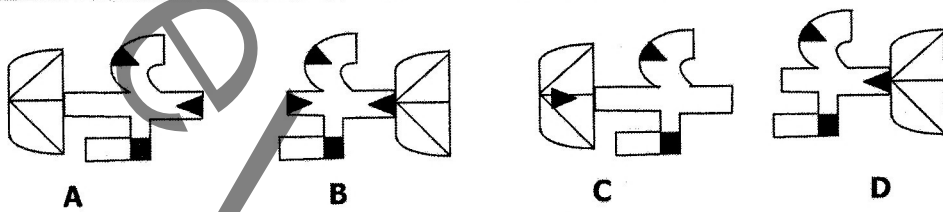
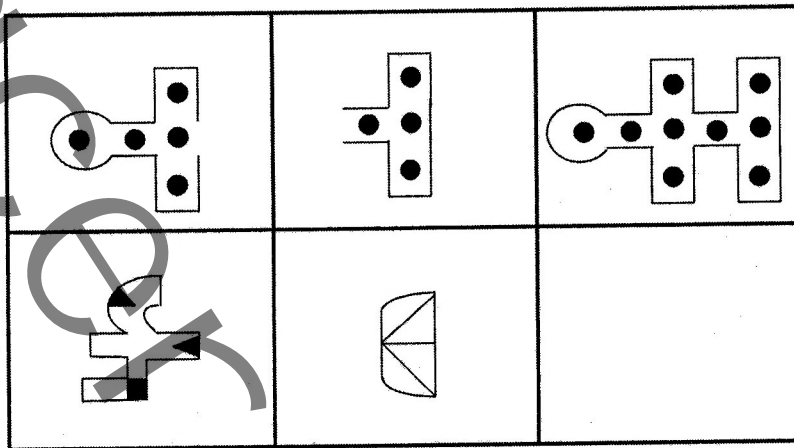

46 WHICH ONE COMES NEXT?

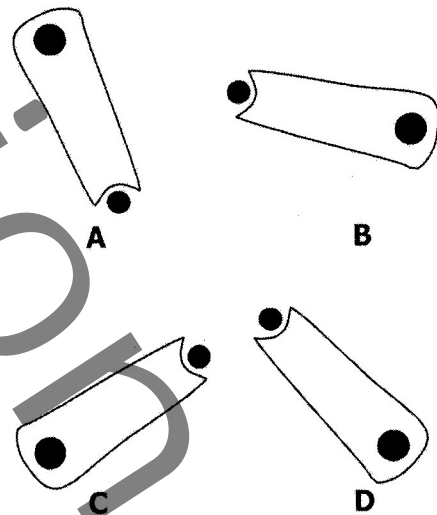
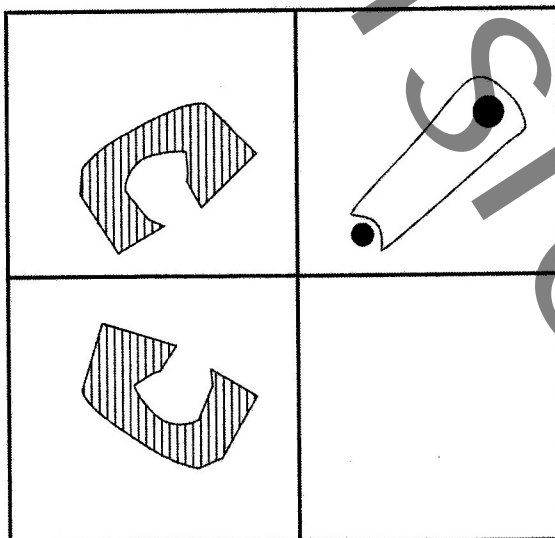

47 WHICH ONE IS DIFFERENT?

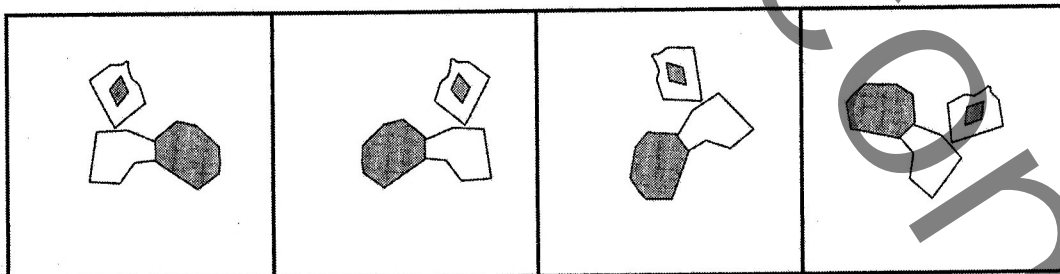

A B C D

48 WHICH ONE COMES NEXT?

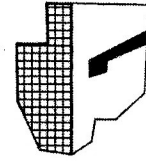
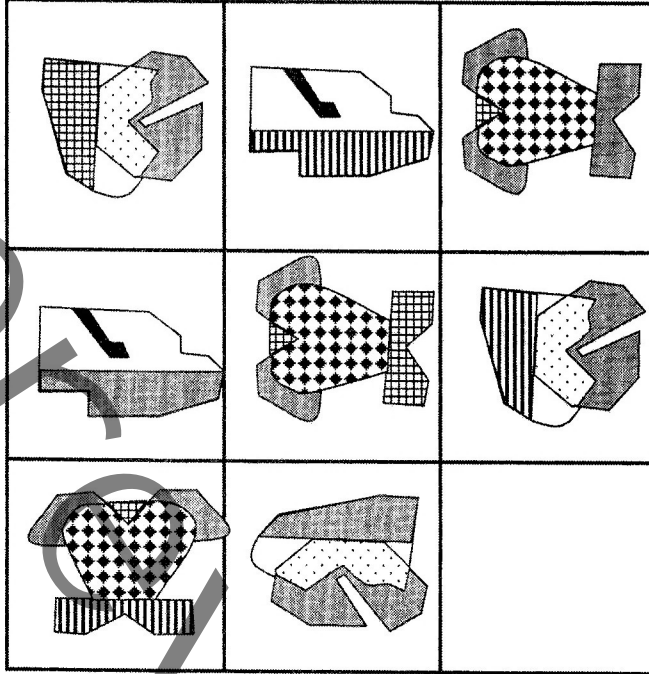

A

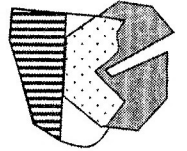

B

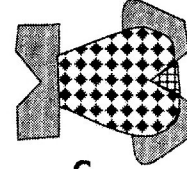

C

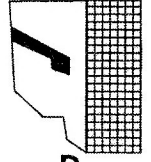

D

49 WHICH ONE COMES NEXT?

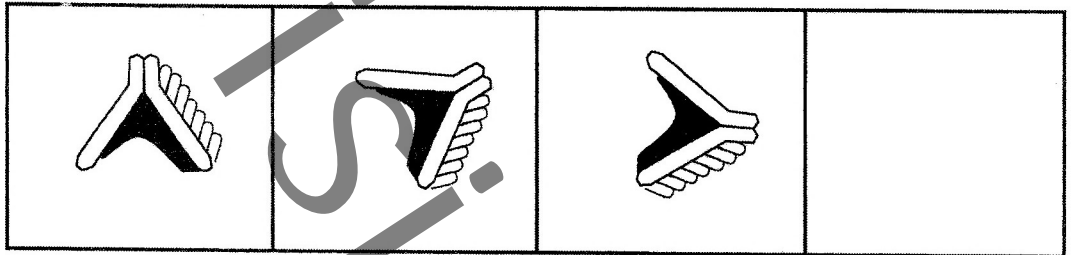

A



B



C



D

50 WHICH ONE COMES NEXT?

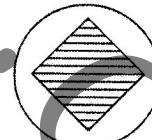
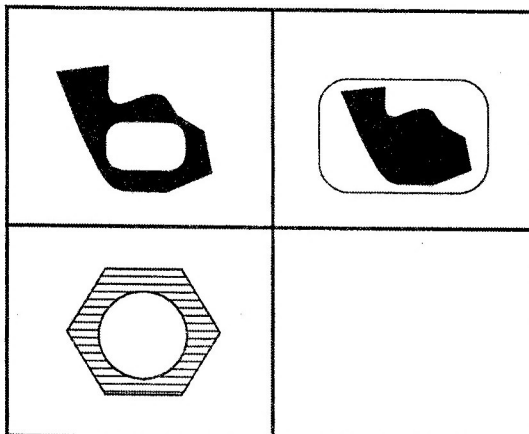

A

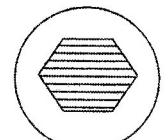

B



C

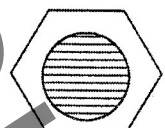

D

STOP! PLEASE GO BACK AND CHECK YOUR WORK